

27 Inch Plastic Shell IT Monitor

MW-LC27



Features

- Resolution is up to at 1920×1080 .
- Refresh rate up to 75Hz.
- 178° horizontal and vertical viewing angle.
- Screen can reduce blue light, protect eyes.
- Plastic body, ultra-narrow bezel, light weight and elegant.
- Shielding cover design, effectively preventing electromagnetic radiation.
- Stable structure design, highly durable.
- Automatically detect if the signal is connected successful.
- Support multiple language.

Specifications

Panel	Description
Panel Type	LED Backlight
Panel Size	27
Pixel Pitch (H*V) (mm)	0.31*0.31
Resolution	1920*1080
Color Support	16.7M
Brightness (cd/m ²)	250
Contrast Ratio	4000:1
Refresh Rate	75Hz
Response Time (ms)	19
Viewing Angle (H/V)	Horizontal 178° , Vertical 178°
Operation Hour	18/7
Interface	Description
Video Input	1* HDMI、1*VGA
VESA	Description
VESA (mm)	100*100
Wall-mounted Thread	4-M4 Threaded hole
OSD	Description
Multi-Language	16 (English, French, Spanish, Portuguese, German, Italian, Dutch, Swedish, Finnish, Polish, Czech, Russian, Korean, Chinese Simplified, Chinese Traditional, Japanese)
General	Description
Input Voltage	DC 12V, 3A
Typical power consumption (W)	≤36 (on)
Standby power consumption (W)	≤0.5(Standby)
Product Dimensions (W*H*D) (mm)	613.00*446.40*173.50 (With Pedestal)
Package Dimensions (W*H*D) (mm)	671*437*119
Weight (Kg)	Net Weight:3.4 Gross Weight:4.7
Operation Temperature	0° C ~ 50° C
Operating Humidity	10%~90% (No Condensation)
Storage Temperature	-10° C ~ 50° C
Storage Humidity	10%~90% (No Condensation)

Dimensions

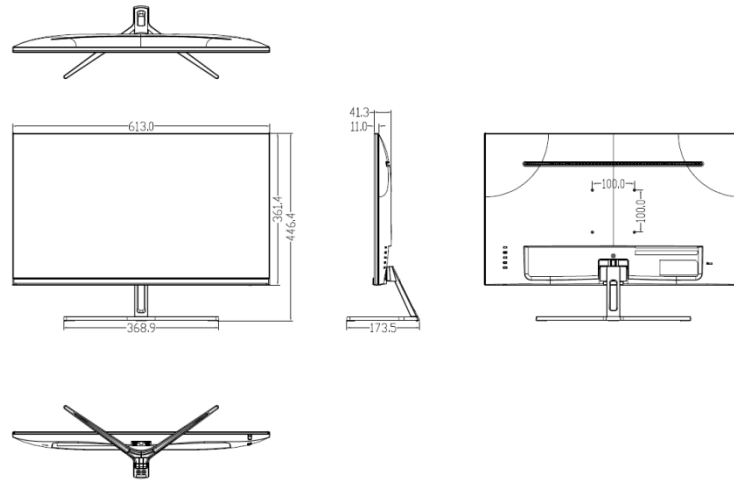

Interface

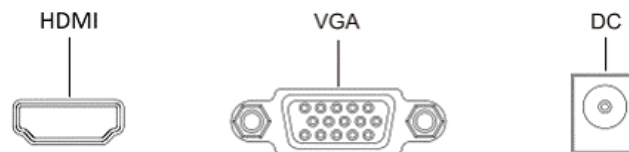

Zhejiang Uniview Technologies Co., Ltd.

No. 369, Xietong Road, Xixing Sub-district, Binjiang District, Hangzhou City, 310051, Zhejiang Province, China

Email: overseasbusiness@uniview.com; globalsupport@uniview.com

<http://www.uniview.com>

©2023-2024 Zhejiang Uniview Technologies Co., Ltd. All rights reserved.

*Product specifications and availability are subject to change without notice.

*Despite our best efforts, technical or typographical errors may exist in this document. Uniview cannot be held responsible for any such errors and reserves the right to change the contents of this document without prior notice.